

4 Halatlı Aktif Tip Ard Germe Grubu 4 Strand Active Post Tension Group

AG-4

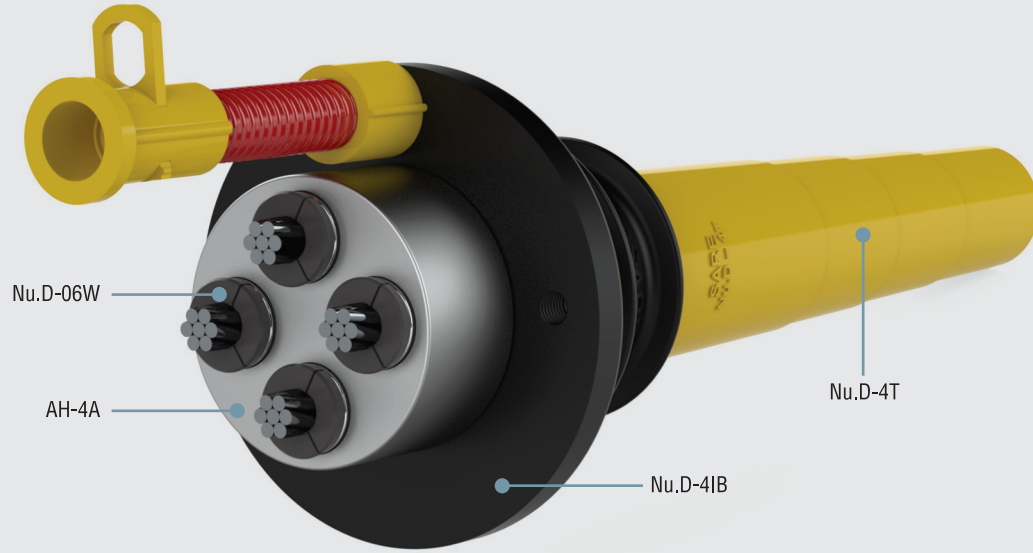

AG-4	Adet / Number	(t) Sayfa / Page
AH-4A	1	33
Nu.D-4IB	1	34
Nu.D-4T	1	35
Nu.D-06W	4	32
Germe Krikosu / Stressing Jack		(t) Sayfa / Page
SJM-240 / 300		37
Galvaniz Boru / Galvanized Corrugated Duct		(t) Sayfa / Page
GSP-4		38
Grup Kapasitesi / Group Capacity		
0.5"		920 kN
0.6"		1104 kN
0.62"		1140 kN

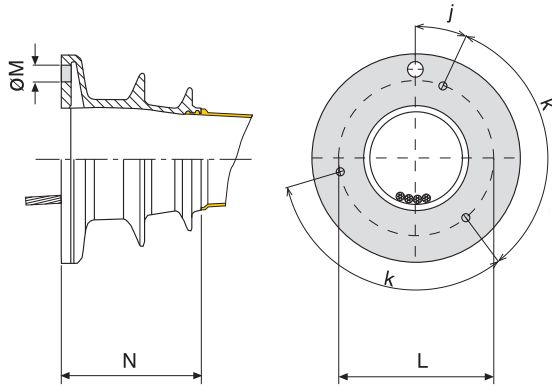

Model No.	J	K	L	M	N
	Ø (mm)	Ø (mm)	Ø (mm)	Ø (mm)	mm
Nu.D-4IB	90°	180°	124	G 3/4"	110

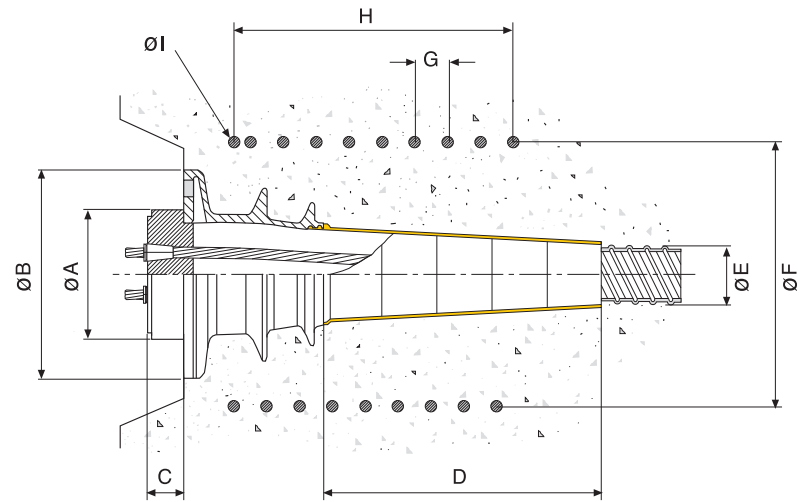

Model No.	A	B	C	D	E	F	G	H	I
	Ø (mm)	Ø (mm)	mm	mm	Ø (mm)	Ø (mm)	mm	mm	Ø (mm)
AG-4	120	175	48	308	47	170	50	300	10